

Product Data Sheet

☎ 1-855-276-5772 or 780-702-7577
 📧 info@kpperformance.com
 ✉ 9850 W 190th St, Suite F, Mokena, IL 60448



KP-5PDC5C-2

4.9 GHz to 6.4 GHz, 2-Foot Parabolic Dish Antenna with Mimosa C5c Quick-Connect Adapter

- Simplified installation with patent pending quick-connect waveguide technology and weatherproofed, cable-less, push-in adapter designed specifically for the Mimosa® C5c™ radio.
- Optimized front to back and side lobes suppression exceeding ETSI 302 217 Class I, eliminating interference
- Heavy-duty bracket with fine elevation and azimuth adjustment
- Snap-on radome sold separately (KP-5PDR-2)

Electrical Specification

Frequency Band	MHz	4900-5400	5400-5900	5900-6400
Gain	dBi	27.5±0.5	28.7±0.5	29.5±0.5
Polarization		H/V or ±45 Slant		
Horizontal HPBW	Degree	5.2±0.4	4.7±0.2	4.4±0.2
Vertical HPBW	Degree	5.3±0.3	4.7±0.2	4.3±0.2
Electrical Compliance		ETSI 302 217 Class I		
Front-to-Back Ratio @ 180°±30°	dB	40	40	40
Cross-polarization Ratio over HPBW	dB	30	32	28
VSWR		1.5 typ 1.7 max	1.3 typ 1.5 max	1.3 typ 1.8 max
Return Loss	dB	14 typ 12 max	18 typ 14 max	18 typ 11 max
Port-to-Port Isolation	dB	30	30	23
Max. Input Power per Port	W		50	
Impedance	Ohms		50	

Mechanical Specifications

Diameter, nominal	25"
Antenna Input	Mimosa A5C Adapter
Radome Color	Grey
Dish Main Reflector Color	Grey
Radio Adapter Color	Grey
Radome Material	UV resistant ABS
Wind Load, Axial	988 N 222 lbf (w/o radome) / 543 N 122 lbf (w/ radome)
Wind Velocity, Operational	145 km/h 90 mph
Wind Velocity, Survival	201 km/h 125 mph
Temperature Range	-40° to +60° C -40° to +140° F

Bracket Specifications

Fine Azimuth Adjustment	±20°
Fine Elevation Adjustment	±22°
Mounting Type	Pipe Mount
Net Weight	8kg 17 lb
Mounting pole diameter	19 mm – 114 mm 0.75 in – 4.5 in
Antenna-to-Pipe Distance	172 mm 6.8 in

Product Data Sheet

☎ 1-855-276-5772 or 780-702-7577
 📧 info@kpperformance.com
 ✉ 9850 W 190th St, Suite F, Mokena, IL 60448

Graphical Data

Azimuth Patterns

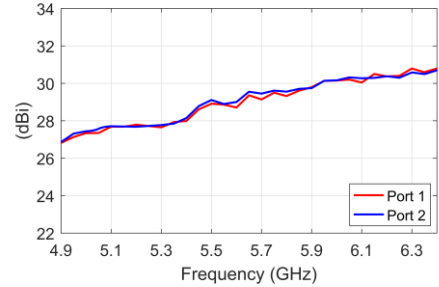
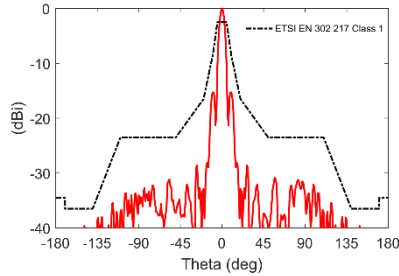
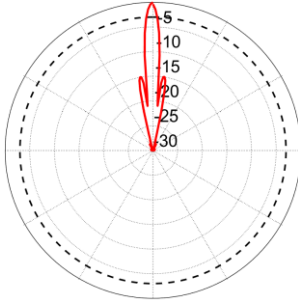

Elevation Patterns

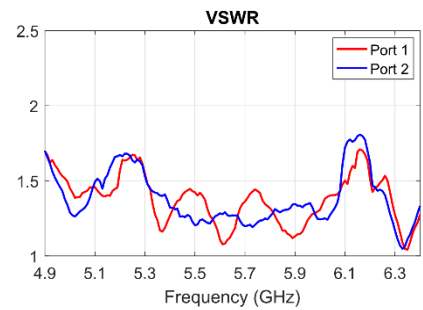
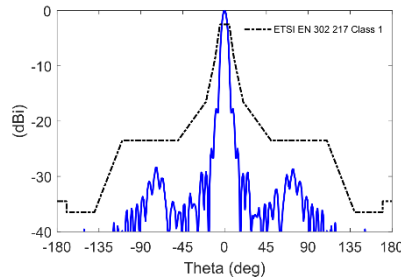
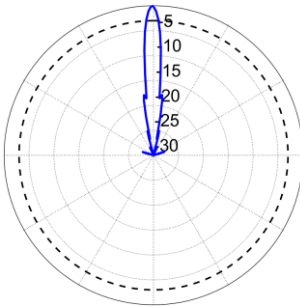

Mechanical Drawings

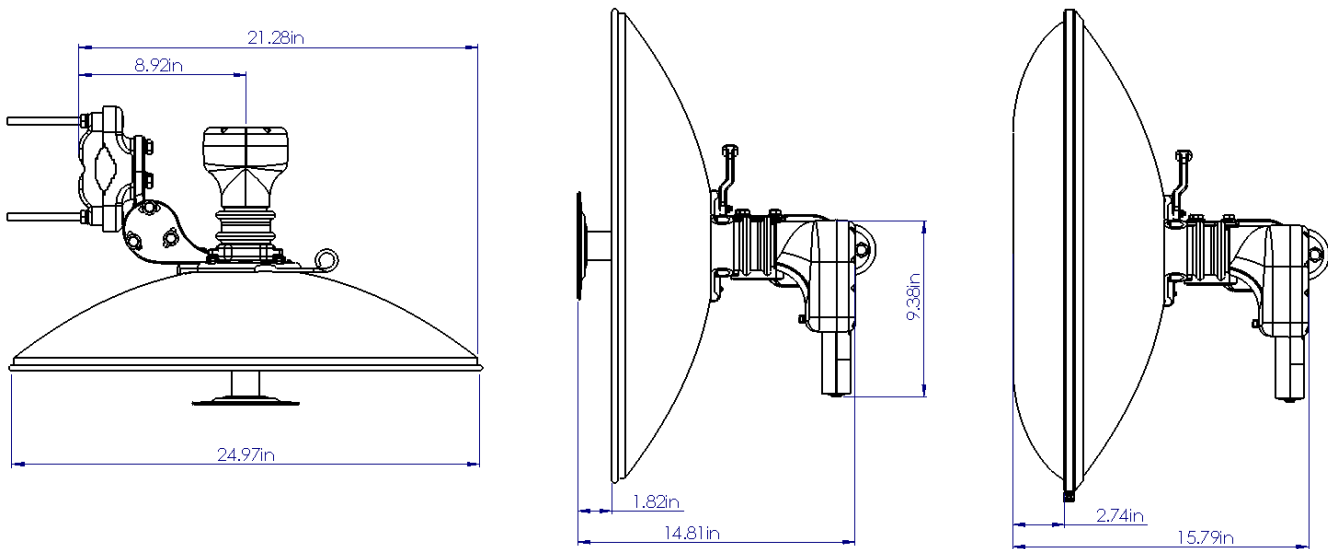

*ALL UNITS IN INCHES

Appendix

HPBW: Average and variation of the antenna's 3dB beamwidth (half power beamwidth) in its horizontal (Azimuth) or vertical (Elevation) pattern.

Gain: Antenna's average gain and variation in each frequency band.

Front to Back Ratio @ $180^\circ \pm 30^\circ$: Difference between the antenna's maximum gain and the maximum gain in the antenna's back lobe over $\pm 30^\circ$ angles.

Cross-polarization Ratio over HPBW (dB): Maximum difference between the co-polarization and cross-polarization gain across the sector's HPBW.